

Igo M 14

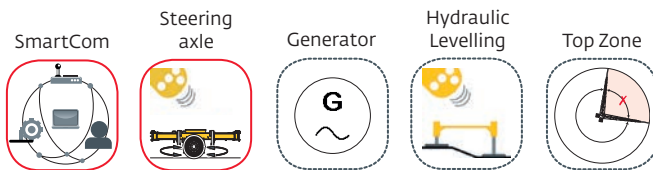

Courbes de charges / Lastkurven / Load curves / Curvas de cargas / Curve di carico
 Curvas de carga / Кривые нагрузок

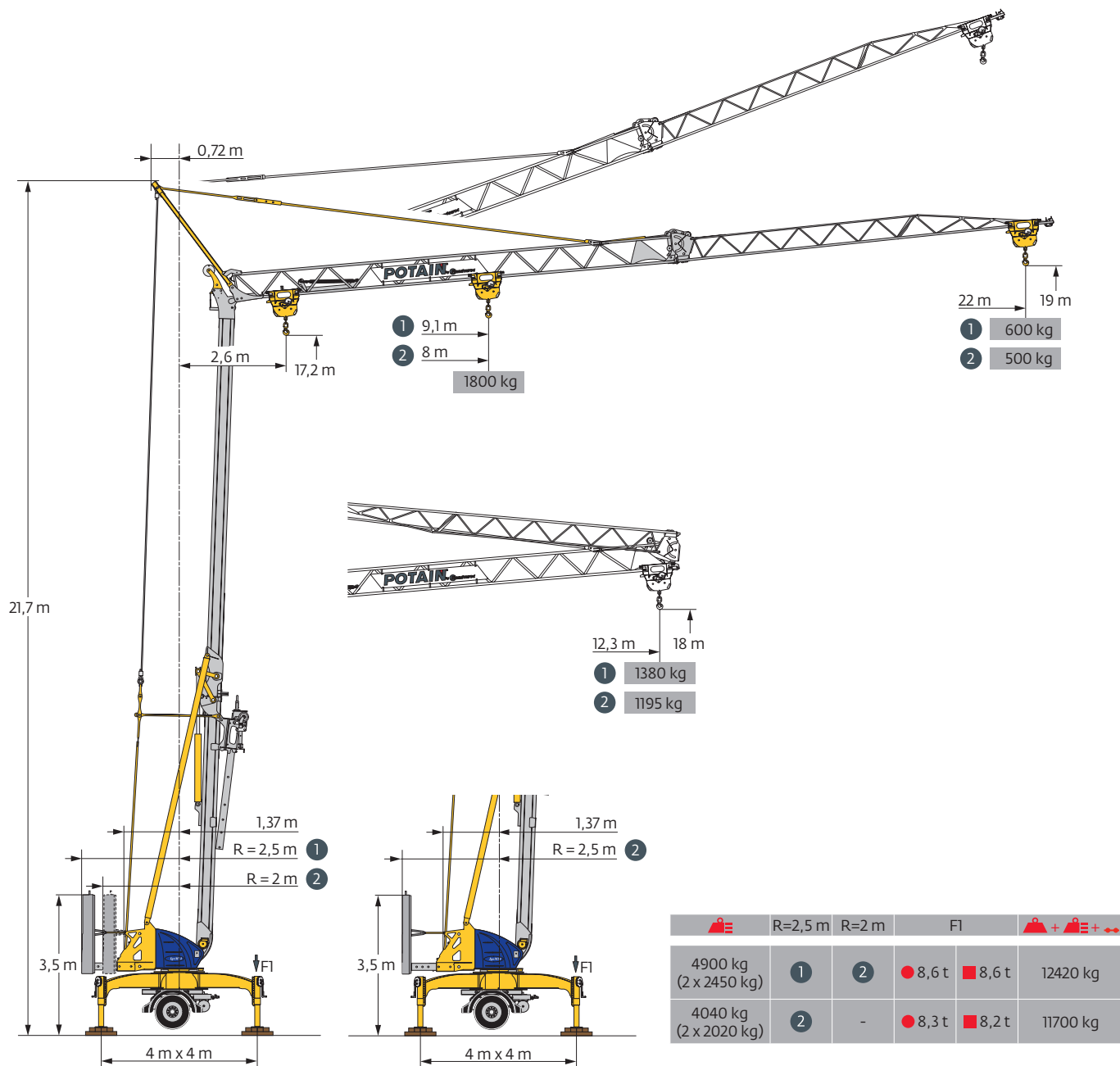
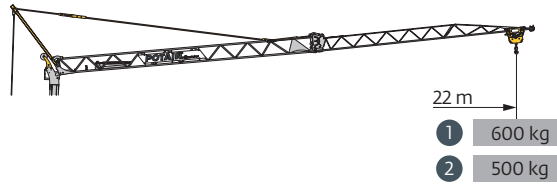
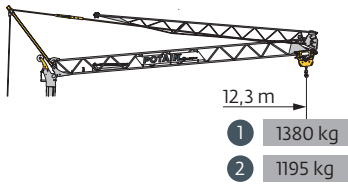

22 m

①	2,6	▶	9,9	11	12	12,3	m					
							1800	1585	1425	1380	kg	
②	2,6	▶	8,9	10	11	12	12,3	m				
							1800	1550	1375	1230	1195	kg

	9,1	10	11	12	13	14	15	16	17	18	19	20	21	22	m															
															1800	1600	1420	1275	1155	1055	970	895	830	770	720	675	635	600	kg	
	8	9	10	11	12	13	14	15	16	17	18	19	20	21	22	m														
															1800	1555	1360	1205	1080	975	890	815	750	695	650	605	565	530	500	kg

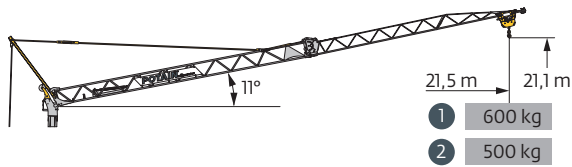

22 m



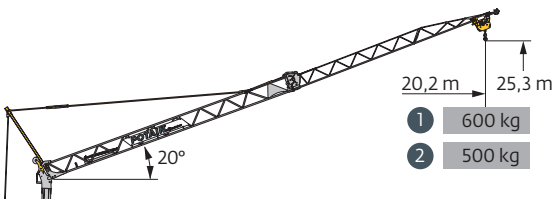

①	2,6	▶	12,3	13	14	15	16	17	18	19	20	21	21,5	m												
														1200	1125	1025	940	870	805	750	700	660	620	600	kg	
②	2,6	▶	10,8	12	13	14	15	16	17	18	19	20	21	21,5	m											
														1200	1050	950	865	795	730	675	630	585	550	515	500	kg



22 m

①	2,6	▶											20,2	m	
														600	kg
②	2,6	▶											20,2	m	
														500	kg

Mécanismes / Triebwerke / Mechanisms / Mecanismos / Meccanismi
Mecanismos / Механизмы

230 V - 50 Hz 400 V - 50 Hz 480 V - 60 Hz							ch - PS hp	kW
	8 LVF 9 Optima	230 V \neq	m/min	\updownarrow 3,5	\up 5 \downarrow 12,5	\up 11,5 \downarrow 39	3,3	2,4
		20 A 1	kg	1800	1800	700		
		230 V \neq	m/min	\updownarrow 3,5	\up 6,5 \downarrow 12,5	\up 22 \downarrow 39	5,2	3,8
		32 A 2	kg	1800	1800	700		
		400 V \neq	m/min	\updownarrow 3,5	\updownarrow 12,5	\updownarrow 39	7,5	5,5
		480 V 3	kg	1800	1800	700		
	1 DVF 4		m/min	14 - 28			1,5	1,1
	RVF 20		tr/min U/min rpm	0 \rightarrow 1			1,5	1,1

 IEC 60204-32	kVA
230 V (+10% -10%) 50 Hz 400 V (+10% -10%) 50 Hz 480 V (+6% -10%) 60 Hz	230 V 20 A : 4,6 kVA 230 V 32 A : 7,4 kVA 400 V / 480 V : 11 kVA

8 LVF 9 Optima

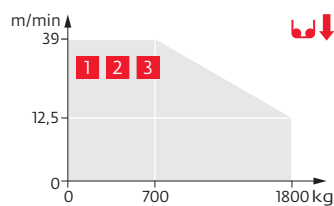
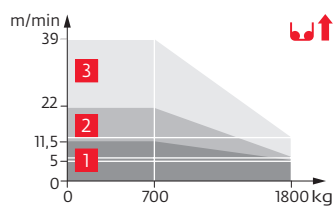

Montage / Montage / Erection / Montaje / Montaggio
Montagem / Монтаж

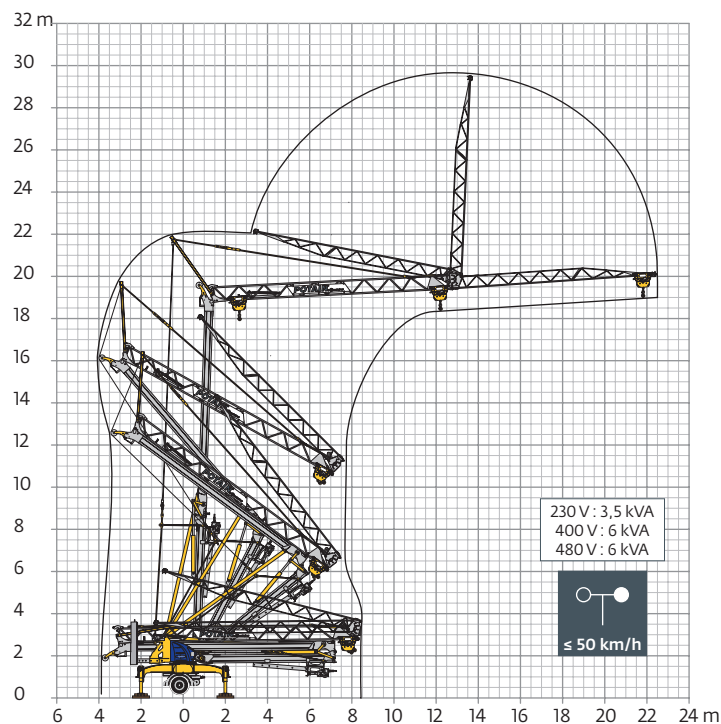

Transport / Transport / Transport / Transporte / Trasporto
Transporte / Транспортировка

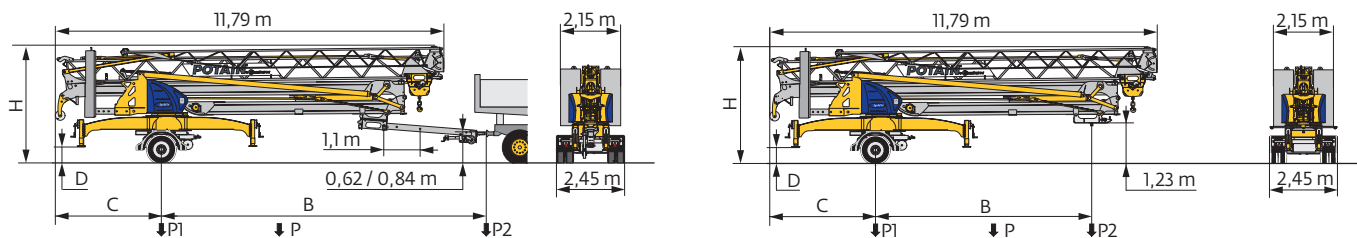

	km/h	⚖️ (kg)	R (m)	B (m)	C (m)	D (m)	H (m)	P (kg)	P1 (kg)	P2 (kg)
🚧 T11/J136	25	4900	2,5	8,71 / 9,81	3,24	0,43	3,47	12500	11940/11970	560/530
	25	4900	2	8,71 / 9,81	3,24	0,43	3,47	12500	11660/11710	840/790
🚧 T11/J125 (EBS)	80	4900	2,5	8,77 / 9,86	3,19	0,5	3,54	12420	11970/12000	450/420
	80	4900	2	8,77 / 9,86	3,19	0,5	3,54	12420	11700/11750	720/670
	80	4040	2,5	8,47	3,52	0,5	3,54	11700	11250	450
🚧 SL011/J136	25	4900	2,5	6,81	3,24	0,43	3,47	12600	12000	600
	25	4900	2	6,81	3,24	0,43	3,47	12600	11620	980
🚧 SL011/J125 (EBS)	80	4900	2,5	6,86	3,19	0,5	3,54	12520	11850	670
	80	4900	2	6,86	3,19	0,5	3,54	12520	11480	1040

Conteneur High Cube 40' & Open Top 40' / Container High Cube 40' & Open Top 40' / Conteneur High Cube 40' & Open Top 40'
Contenedor High Cube 40' & Open Top 40' / Container High Cube 40' & Open Top 40' / Contentor High Cube 40' & Open Top 40'
40-футовый контейнер повышенной вместимости High Cube & Open Top.



	FR	DE	EN	ES	IT	PT	RU
R	Rayon de giration	Schwenk radius	Rear slewing radius	Radio de giro	Raggio di rotazione	Raio de rotação	Задний габарит
●	Réactions en service	Reaktionskräfte in Betrieb	Reactions in service	Reacciones en servicio	Reazioni in servizio	Reacções em serviço	Реакция при работе
■	Réactions hors service	Reaktionskräfte außer Betrieb	Reactions out of service	Reacciones fuera de servicio	Reazioni fuori servizio	Reacções fora de serviço	Реакция в покое
⚖️	Poids à vide, sans lest, sans trains de transport, avec flèche maxi. et hauteur standard.	Gewicht ohne Last, ohne Ballast, ohne Transportachsen, mit max. Auslager und Standardhöhe	Weight without load, without ballast, without transport axes, with max. jib and standard height	Peso en vacío, sin lastre, sin trenes de transporte con flecha y altura estandar	Peso a vuoto, senza zavorra, senza assali di trasporto, con braccio max e altezza standard.	Peso em vazio, sem lastro, sem eixos de transporte com lança máxima e altura standard.	Вес без груза, без балласта, без осей для транспортировки, с максимальным вылетом стрелы и стандартной высотой
⚖️	Poids total du lest	Ballast-Gesamtgewicht	Total ballast weight	Peso total del lastre	Peso totale della zavorra	Peso total do lastro	Общий вес балласта
🚃	Trains de transport	Transportachsen	Transport axes	Trenes de transporte	Assali di trasporto	Eixos de transporte	Осей для транспортировки
📦	Équipements standards	Standardausrüstungen	Standard equipment	Equipamiento de serie	Equipaggiamento standard	Equipamento de série	Стандартное оборудование
📦	Équipements optionnels	Sonderausrüstungen	Options	Equipamiento opcional	Equipaggiamento in opzione	Equipamento opcional	Дополнительное оборудование (опция)
⬆️	Levage	Heben	Hoisting	Elevación	Sollevamento	Elevação	Подъем
➡️	Distribution	Katzfahren	Trolleying	Distribución	Distribuzione	Distribuição	Перемещение по стреле
🔄	Orientation	Schwenken	Slewing	Orientación	Rotazione	Rotação	Поворот
⚡	50 Hz Monophasé	50 Hz Einphasige	50 Hz Single phase	50 Hz Monofasica	50 Hz Monofase	50 Hz monofásica	Однофазное напряжение 50Hz
⚡	Puissance requise	Erforderliche Leistung	Required power	Potencia Necesaria	Potenza richiesta	Potência necessária	Потребляемая мощность
🚃	Transport grue toute lestée.	Krantransport mit voller Ballastierung.	Transport of crane with full ballast.	Transporte grúa completa-mente lastrada.	Trasporto con gru completa-mente zavorrata.	Transporte de grua totalmente balastrada.	Перевозка крана с полным балластом
⚠️	Document commercial non contractuel. Pour toute information technique se référer à la notice correspondante.	Unverbindliches Vertriebsdokument. Für technische Informationen, siehe die entsprechenden Anweisungen.	This commercial document is not legally binding. For any technical information, please refer to the corresponding instructions.	Documento comercial no contractual. Para cualquier información técnica, ver la noticia correspondiente.	Documento commerciale non vincolante, per tutte le informazioni tecniche fare riferimento al catalogo istruzioni.	Documento comercial não contratual. Para qualquer informação técnica complementar consultar as respectivas instruções.	Этот коммерческий документ не является юридически обязательным. Для получения технической информации, см. соответствующие инструкции.

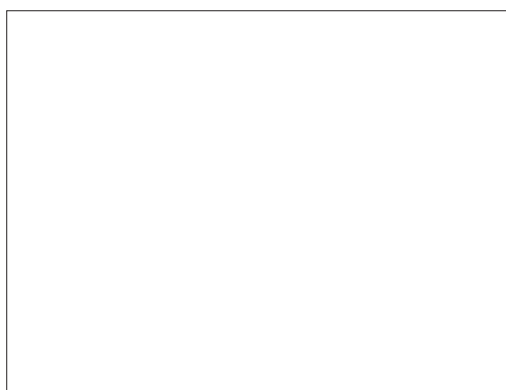

Americas
Manitowoc, Wisconsin, USA
Tel: +1 920 684 6621
Fax: +1 920 683 6277

Shady Grove, Pennsylvania, USA
Tel: +1 717 597 8121
Fax: +1 717 597 4062

Europe, Middle East, Africa
Dardilly, France
Tel: +33 (0)4 72 18 20 20
Fax: +33 (0)4 72 18 20 00

China
Shanghai, China
Tel: +86 21 6457 0066
Fax: +86 21 6457 4955

Greater Asia-Pacific
Singapore
Tel: +65 6264 1188
Fax: +65 6862 4040